

2005-05-10

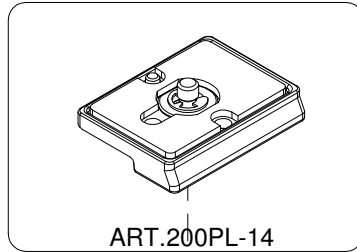

ART.200PL-14

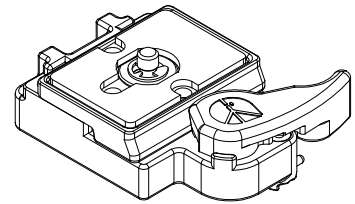
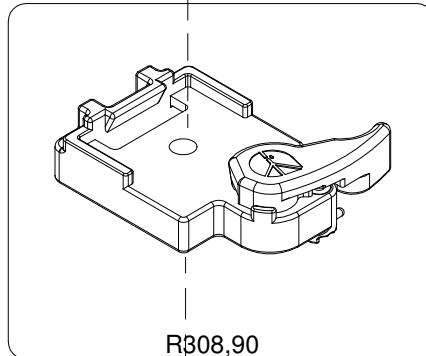

R308,90

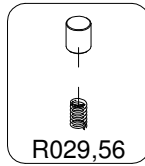

R029,56

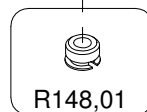

R148,01

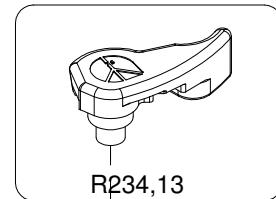

R234,13

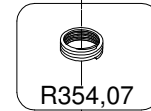

R354,07

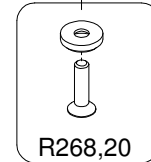

R268,20